

PLEASE CHECK WWW.MOLEX.COM FOR LATEST PART INFORMATION

Part Number: [0311000040](#)
Status: **Active**
Overview: [hdac 64 single row](#)
Description: H-DAC 64™ 2.54mm (.100") 4 Way Right Angle Header Assembly, Polarization A

Documents:

[Drawing \(PDF\)](#) [Product Specification PS-31100-0001 \(PDF\)](#)
[Application Specification \(PDF\)](#) [RoHS Certificate of Compliance \(PDF\)](#)

General

Product Family	PCB Headers
Series	31100
Application	Wire-to-Board
Comments	Polarization Option A, Black
Overview	hdac 64 single row
Product Name	N/A

Physical

Breakaway	No
Circuits (Loaded)	4
Circuits (maximum)	4
Color - Resin	Black
Durability (mating cycles max)	10
First Mate / Last Break	No
Glow-Wire Compliant	No
Guide to Mating Part	No
Keying to Mating Part	None
Lock to Mating Part	Yes
Material - Metal	Brass
Material - Plating Mating	Tin
Material - Plating Termination	Nickel
Material - Resin	Modified Polystyrene
Number of Rows	1
Orientation	Right Angle
PC Tail Length (in)	0.139 In
PC Tail Length (mm)	3.52 mm
PCB Locator	Yes
PCB Retention	Yes
PCB Thickness Recommended (in)	0.062 In
PCB Thickness Recommended (mm)	1.57 mm
Packaging Type	Tray
Pitch - Mating Interface (in)	0.100 In
Pitch - Mating Interface (mm)	2.54 mm
Pitch - Term. Interface (in)	0.100 In
Pitch - Term. Interface (mm)	2.54 mm
Plating min: Mating (µin)	60
Plating min: Mating (µm)	1.50
Plating min: Termination (µin)	60
Plating min: Termination (µm)	1.50
Polarized to Mating Part	Yes
Polarized to PCB	Yes
Shrouded	Closed Ends
Stackable	No
Surface Mount Compatible (SMC)	No
Temperature Range - Operating	-40°C to +100°C
Termination Interface: Style	Through Hole

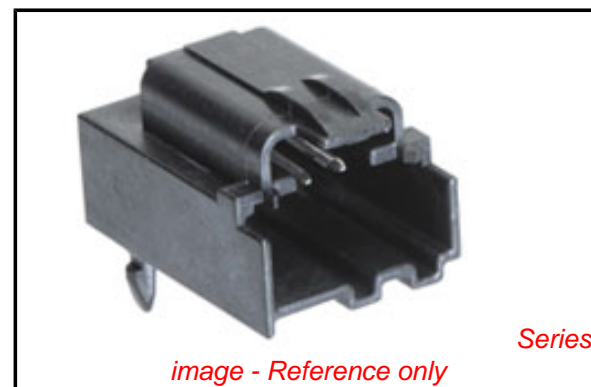

image - Reference only

EU RoHS

ELV and RoHS Compliant
REACH SVHC Contains SVHC: No
Halogen-Free Status
Halogen-Free

China RoHS



Need more information on product environmental compliance?

Email productcompliance@molex.com
 For a multiple part number RoHS Certificate of Compliance, [click here](#)

Please visit the [Contact Us](#) section for any non-product compliance questions.

Search Parts in this Series

[31100Series](#)

Mates With

H-DAC 64™, 4 Way Receptacle Assembly
[310681010](#)

Electrical

Current - Maximum per Contact 5A, 7A
Voltage - Maximum 500V DC

Solder Process Data

Duration at Max. Process Temperature (seconds) 40
Lead-free Process Capability SMC & Wave Capable (TH only)
Max. Cycles at Max. Process Temperature 3
Process Temperature max. C 260

Material Info**Reference - Drawing Numbers**

Application Specification AS-31067-100
Packaging Specification PK-31300-577
Product Specification PS-31100-0001
Sales Drawing SD-31197-003

This document was generated on 05/24/2010

PLEASE CHECK WWW.MOLEX.COM FOR LATEST PART INFORMATION

3 WAY RIGHT ANGLE
HEADER ASSEMBLY
(POLARIZATION OPTIONS
VIEWED FROM MATE SIDE)

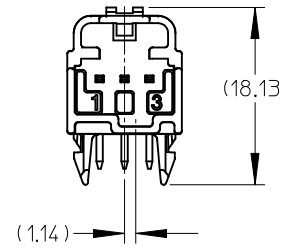
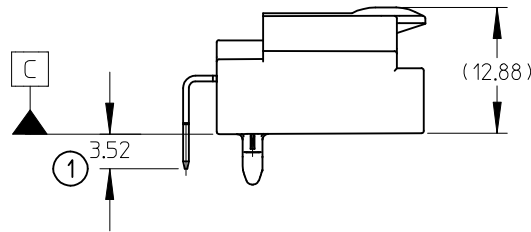
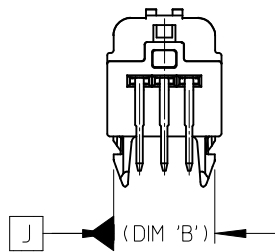
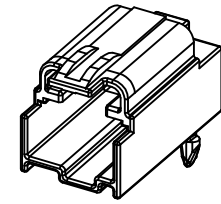
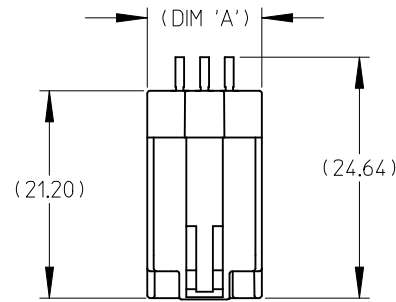

OPTION "A"

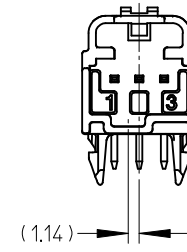

OPTION "B"

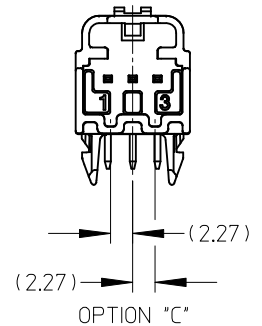

OPTION "C"

SEE DETAIL 1

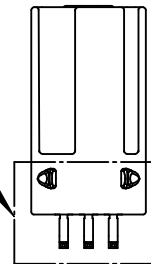

NOTES:

1. MATERIAL:
HOUSING: SYNDIOTATIC POLYSTYRENE (SPS).
COLOR: SEE CHART.
TERMINAL: BRASS.
2. FINISH:
TERMINAL: 60 MICROINCHES MIN NICKEL (Ni)
UNDERPLATE OVERALL. 60 MICROINCHES MIN
SELECTIVE TIN (Sn).
3. PRODUCT SPEC NUMBER PS-31100-0001.
4. PACKAGING PER PACKAGING SPEC.: SEE CHART.
5. MATES WITH SEE CHART.

ENTER DESCRIPTION EC NO: UAU2009-0141 TDRWN:CDILLON 2008/09/15 CHKD:CDILLON 2008/09/15 APPR:SMARCEAU 2008/09/15	QUALITY SYMBOLS ▽=0 ▽=0	GENERAL TOLERANCES (UNLESS SPECIFIED)		DIMENSION STYLE MM ONLY		SCALE 2:1	DESIGN UNITS METRIC	THIRD ANGLE PROJECTION	
			mm	INCH	DRAWN BY MDEVITO	DATE 01/12/06	TITLE RIGHT ANGLE HEADER ASSEMBLY CHARTED SALES DRAWING MOLEX INCORPORATED		
					CHECKED BY BCOURIM	DATE 01/12/07			
					APPROVED BY GMEYER	DATE 01/12/07	DOCUMENT NO. SD-31197-003	SHEET NO. 1 OF 8	
DRAFT WHERE APPLICABLE MUST REMAIN WITHIN DIMENSIONS		MATERIAL NO. SEE CHART		THIS DRAWING CONTAINS INFORMATION THAT IS PROPRIETARY TO MOLEX INCORPORATED AND SHOULD NOT BE USED WITHOUT WRITTEN PERMISSION					

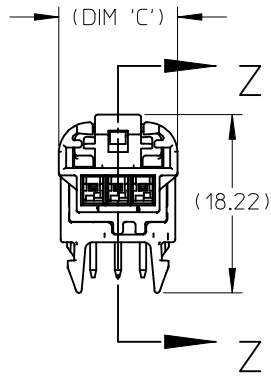
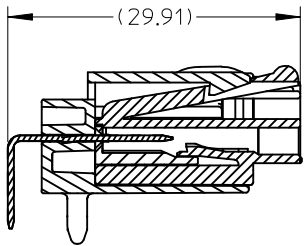
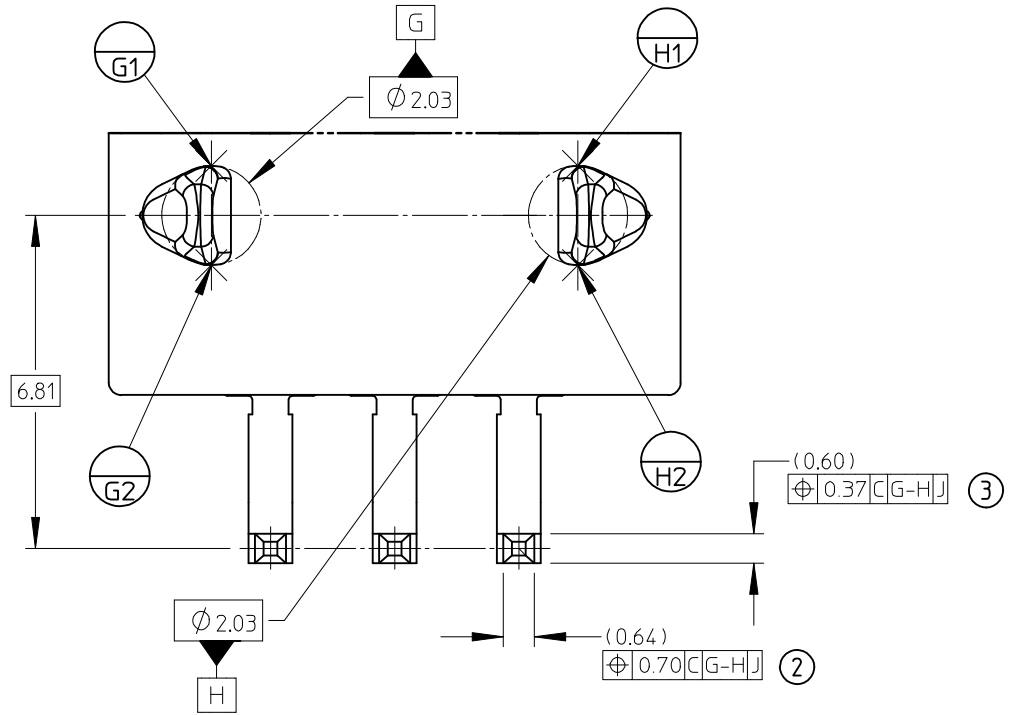

SECTION Z-Z
SCALE 2:1

FULLY SEATED ASSEMBLY

DETAIL1
SCALE 10:1

ENTER DESCRIPTION EC NO: UAU2009-0141 TDRW:CDILLON 2008/09/15 CHKD:CDILLON 2008/09/15 APPR:SMARCEAU 2008/09/15	QUALITY SYMBOLS ▽=0 ▽=0	GENERAL TOLERANCES (UNLESS SPECIFIED)		DIMENSION STYLE MM ONLY		SCALE 1:1	DESIGN UNITS METRIC	THIRD ANGLE PROJECTION		
		4 PLACES	± ---	± ---	DRAWN BY	DATE	TITLE RIGHT ANGLE HEADER ASSEMBLY CHARTED SALES DRAWING			
		3 PLACES	± ---	± ---	MDEVITO	01/12/06				
		2 PLACES	± 0.13	± ---	CHECKED BY	DATE	MOLEX INCORPORATED			
1 PLACE	± 0.25	± ---	BCOURIM	01/12/07						
ANGULAR ±1/2°		APPROVED BY		DATE	DOCUMENT NO.		SHEET NO.			
DRAFT WHERE APPLICABLE MUST REMAIN WITHIN DIMENSIONS		SEE CHART		GMEYER	01/12/07	SD-31197-003	2 OF 8			
THIS DRAWING CONTAINS INFORMATION THAT IS PROPRIETARY TO MOLEX INCORPORATED AND SHOULD NOT BE USED WITHOUT WRITTEN PERMISSION										

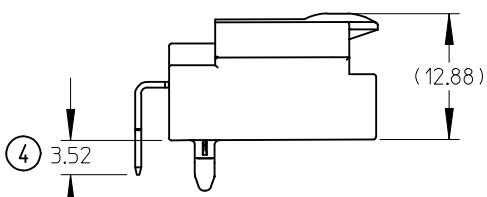

4 WAY RIGHT ANGLE
HEADER ASSEMBLY
(POLARIZATION OPTIONS
VIEWED FROM MATE SIDE)

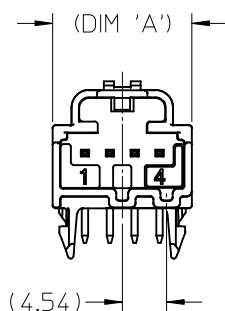

OPTION "A"

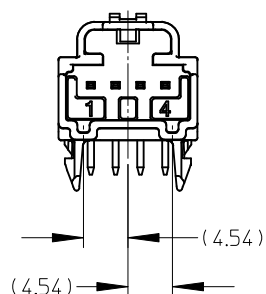

OPTION "B"

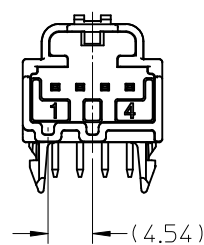

OPTION "C"

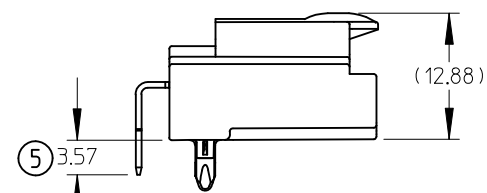
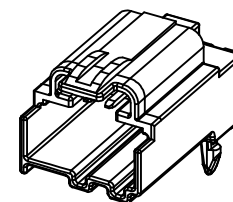

5 WAY RIGHT ANGLE
HEADER ASSEMBLY
(POLARIZATION OPTIONS
VIEWED FROM MATE SIDE)

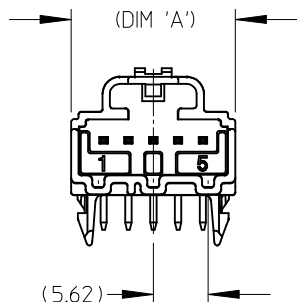

OPTION "A"

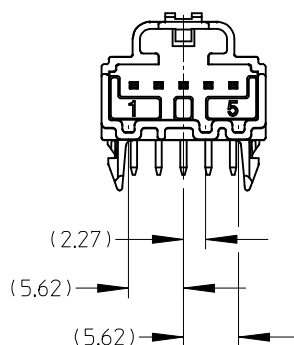

OPTION "B"

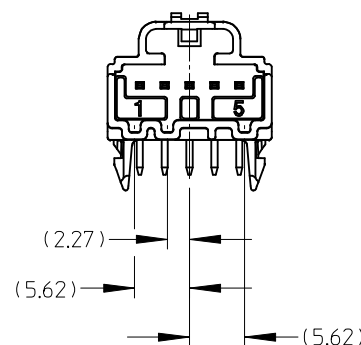

OPTION "C"

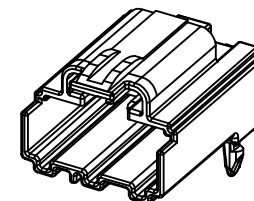

ENTER DESCRIPTION EC NO: JAU2009-0141 TDR:WAGDILLON 2008/09/15 CHKD:CDILLON 2008/09/15 APPR:SMARCEAU 2008/09/15	QUALITY SYMBOLS ▽=0 ▽=0	GENERAL TOLERANCES (UNLESS SPECIFIED)		DIMENSION STYLE MM ONLY		SCALE 2:1	DESIGN UNITS METRIC	THIRD ANGLE PROJECTION
		4 PLACES ± --- ± ---	mm INCH	DRAWN BY MDEVITO	DATE 01/12/06	TITLE RIGHT ANGLE HEADER ASSEMBLY CHARTED SALES DRAWING		
		3 PLACES ± --- ± ---	2 PLACES ± 0.13 ± ---	CHECKED BY BCOURIM	DATE 01/12/07			
		1 PLACE ± 0.25 ± ---	ANGULAR ± 1/2°	APPROVED BY GMEYER	DATE 01/12/07	MOLEX INCORPORATED		
DRAFT WHERE APPLICABLE MUST REMAIN WITHIN DIMENSIONS		MATERIAL NO. SEE CHART		DOCUMENT NO. SD-31197-003		SHEET NO. 3 OF 8		

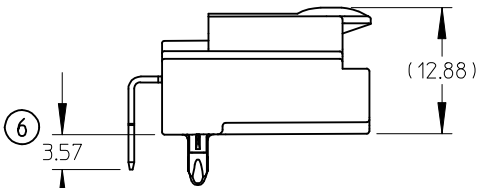

6 WAY RIGHT ANGLE
HEADER ASSEMBLY
(POLARIZATION OPTIONS
VIEWED FROM MATE SIDE)

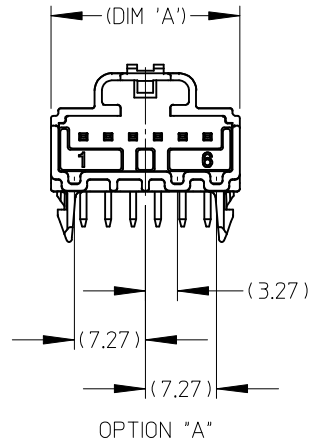

OPTION "A"

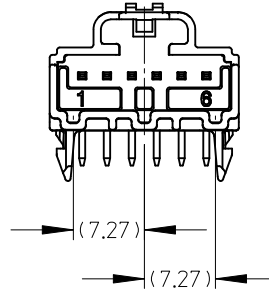

OPTION "B"

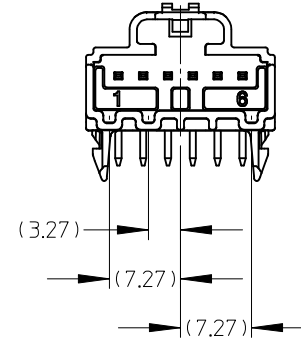

OPTION "C"

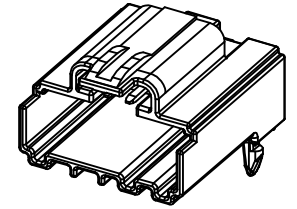

ENTER DESCRIPTION EC NO: UAU2009-0141 TDRW:CDILLON 2008/09/15 CHKD:CDILLON 2008/09/15 APPR:SMARCEAU 2008/09/15	QUALITY SYMBOLS ▽=0 ▽=0	GENERAL TOLERANCES (UNLESS SPECIFIED)		DIMENSION STYLE MM ONLY		SCALE 1:1	DESIGN UNITS METRIC	THIRD ANGLE PROJECTION	
		4 PLACES ± --- ± ---	DRAWN BY MDEVITO	DATE 01/12/06	TITLE RIGHT ANGLE HEADER ASSEMBLY CHARTED SALES DRAWING				
		3 PLACES ± --- ± ---	CHECKED BY BCOURIM	DATE 01/12/07					
		2 PLACES ± 0.13 ± ---	APPROVED BY GMEYER	DATE 01/12/07	MOLEX INCORPORATED				
1 PLACE ± 0.25 ± ---	ANGULAR ± 1/2°		MATERIAL NO. SEE CHART	DOCUMENT NO. SD-31197-003	SHEET NO. 4 OF 8				
DRAFT WHERE APPLICABLE MUST REMAIN WITHIN DIMENSIONS		THIS DRAWING CONTAINS INFORMATION THAT IS PROPRIETARY TO MOLEX INCORPORATED AND SHOULD NOT BE USED WITHOUT WRITTEN PERMISSION							

BILL OF MATERIALS

FEMALE MATING ASSEMBLY	HEADER ASSEMBLY P/N PER DWG. PK-31300-293 (TRAY PKG)	HEADER ASSEMBLY P/N PER DWG. PK-31300-577 (SPEC. TRAY PKG)	DESCRIPTION	COLOR	DIM 'A'	DIM 'B'	DIM 'C'
31067-1010	31100-0030 NOT TOOLED		3 WAY RIGHT ANGLE HEADER ASSEMBLY POLARIZATION "A"	BLACK	11.69	10.33	12.14
31067-1011	31100-0031 NOT TOOLED		3 WAY RIGHT ANGLE HEADER ASSEMBLY POLARIZATION "B"	GRAY	11.69	10.33	12.14
31067-1012	31100-0032 NOT TOOLED		3 WAY RIGHT ANGLE HEADER ASSEMBLY POLARIZATION "C"	BROWN	11.69	10.33	12.14
31068-1010	31100-0040	31100-0049	4 WAY RIGHT ANGLE HEADER ASSEMBLY POLARIZATION "A"	BLACK	14.23	12.87	14.68
31068-1011	31100-0041	31100-0048	4 WAY RIGHT ANGLE HEADER ASSEMBLY POLARIZATION "B"	GRAY	14.23	12.87	14.68
31068-1012	31100-0042	31100-0047	4 WAY RIGHT ANGLE HEADER ASSEMBLY POLARIZATION "C"	BROWN	14.23	12.87	14.68

ENTER DESCRIPTION EC NO: UAU2009-0141 TDRWN:CDILLON 2008/09/15 CHKD:CDILLON 2008/09/15 APPR:SMARCEAU 2008/09/15	QUALITY SYMBOLS ▽=0 ▽=0	GENERAL TOLERANCES (UNLESS SPECIFIED)		DIMENSION STYLE MM ONLY		SCALE	DESIGN UNITS METRIC	THIRD ANGLE PROJECTION		
			mm	INCH	DRAWN BY	DATE	TITLE RIGHT ANGLE HEADER ASSEMBLY CHARTED SALES DRAWING			
		4 PLACES	± ---	± ---	MDEVITO	01/12/06				
		3 PLACES	± ---	± ---	CHECKED BY	DATE	MOLEX INCORPORATED			
2 PLACES	± 0.13	± ---	BCOURIM	01/12/07						
1 PLACE	± 0.25	± ---	APPROVED BY	DATE	DOCUMENT NO.		SHEET NO.			
		ANGULAR ±1/2°	GMEYER	01/12/07	SD-31197-003		5 OF 8			
DRAFT WHERE APPLICABLE MUST REMAIN WITHIN DIMENSIONS			SEE CHART		THIS DRAWING CONTAINS INFORMATION THAT IS PROPRIETARY TO MOLEX INCORPORATED AND SHOULD NOT BE USED WITHOUT WRITTEN PERMISSION					

BILL OF MATERIALS

FEMALE MATING ASSEMBLY	HEADER ASSEMBLY P/N PER DWG. PK-31300-293 (TRAY PKG)	HEADER ASSEMBLY P/N PER DWG. PK-31300-577 (SPEC. TRAY PKG)	DESCRIPTION	COLOR	DIM 'A'	DIM 'B'	DIM 'C'
31072-1010	31100-0050 NOT TOOLED		5 WAY RIGHT ANGLE HEADER ASSEMBLY POLARIZATION "A"	BLACK	16.77	15.41	17.22
31072-1011	31100-0051 NOT TOOLED		5 WAY RIGHT ANGLE HEADER ASSEMBLY POLARIZATION "B"	GRAY	16.77	15.41	17.22
31072-1012	31100-0052 NOT TOOLED		5 WAY RIGHT ANGLE HEADER ASSEMBLY POLARIZATION "C"	BROWN	16.77	15.41	17.22
31073-1010	31100-0060 NOT TOOLED		6 WAY RIGHT ANGLE HEADER ASSEMBLY POLARIZATION "A"	BLACK	19.31	17.95	19.76
31073-1011	31100-0061 NOT TOOLED		6 WAY RIGHT ANGLE HEADER ASSEMBLY POLARIZATION "B"	GRAY	19.31	17.95	19.76
31073-1012	31100-0062 NOT TOOLED		6 WAY RIGHT ANGLE HEADER ASSEMBLY POLARIZATION "C"	BROWN	19.31	17.95	19.76

ENTER DESCRIPTION EC NO: UAU2009-0141 TDR: MCDILLON 2008/09/15 CHKD: EDILLON 2008/09/15 APPR: SMARCEAU 2008/09/15	QUALITY SYMBOLS ▽=0 ▽7=0	GENERAL TOLERANCES (UNLESS SPECIFIED)		DIMENSION STYLE MM ONLY		SCALE 1:1	DESIGN UNITS METRIC	THIRD ANGLE PROJECTION		
			mm	INCH	DRAWN BY	DATE	TITLE RIGHT ANGLE HEADER ASSEMBLY CHARTED SALES DRAWING			
		4 PLACES	±---	±---	MDEVITO	01/12/06				
		3 PLACES	±---	±---	CHECKED BY	DATE	MOLEX INCORPORATED			
2 PLACES	±0.13	±---	BCOURIM	01/12/07						
1 PLACE	±0.25	±---	APPROVED BY	DATE	DOCUMENT NO.		SHEET NO.			
	ANGULAR ±1/2°		GMEYER	01/12/07	SD-31197-003		6 OF 8			
DRAFT WHERE APPLICABLE MUST REMAIN WITHIN DIMENSIONS			SEE CHART		THIS DRAWING CONTAINS INFORMATION THAT IS PROPRIETARY TO MOLEX INCORPORATED AND SHOULD NOT BE USED WITHOUT WRITTEN PERMISSION					

RECOMMENDED PCB LAYOUT

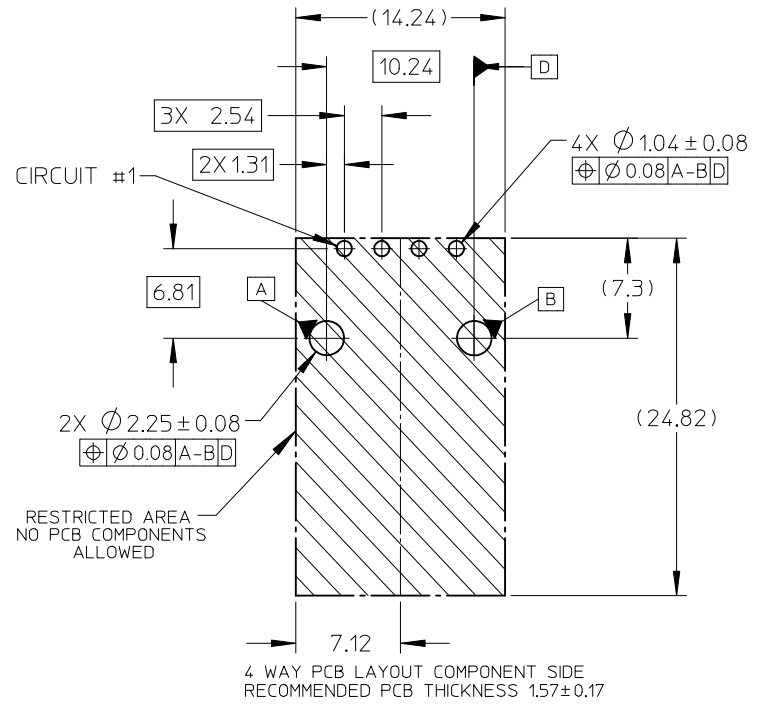
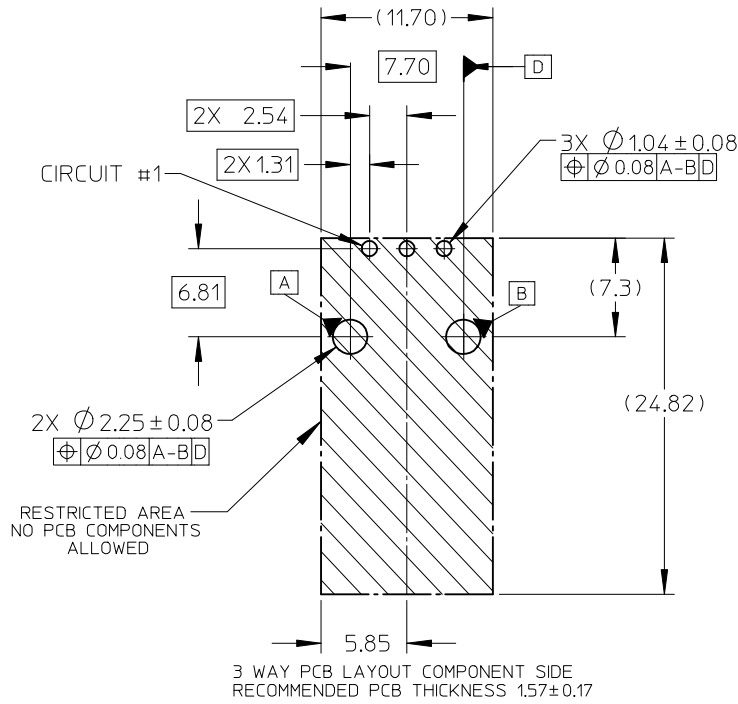

ENTER DESCRIPTION EC NO: UAU2009-0141 DRAWN: EDILLON 2008/09/15 CHKD: EDILLON 2008/09/15 APPR: SMARCEAU 2008/09/15	QUALITY SYMBOLS ▽=0 ▽7=0	GENERAL TOLERANCES (UNLESS SPECIFIED)		DIMENSION STYLE MM ONLY		SCALE 1:1	DESIGN UNITS METRIC	THIRD ANGLE PROJECTION	
		mm	INCH	DRAWN BY	DATE	TITLE RIGHT ANGLE HEADER ASSEMBLY CHARTED SALES DRAWING			
		4 PLACES ± ---	± ---	MDEVITO	01/12/06				
		3 PLACES ± ---	± ---	CHECKED BY	DATE	MOLEX INCORPORATED			
2 PLACES ± 0.13	± ---	BCOURIM	01/12/07						
1 PLACE ± 0.25	± ---	APPROVED BY	DATE	MATERIAL NO.		DOCUMENT NO.	SHEET NO.		
ANGULAR ±1/2°		DRAFT WHERE APPLICABLE MUST REMAIN WITHIN DIMENSIONS		SEE CHART		SD-31197-003	7 OF 8		
THIS DRAWING CONTAINS INFORMATION THAT IS PROPRIETARY TO MOLEX INCORPORATED AND SHOULD NOT BE USED WITHOUT WRITTEN PERMISSION									

RECOMMENDED PCB LAYOUT

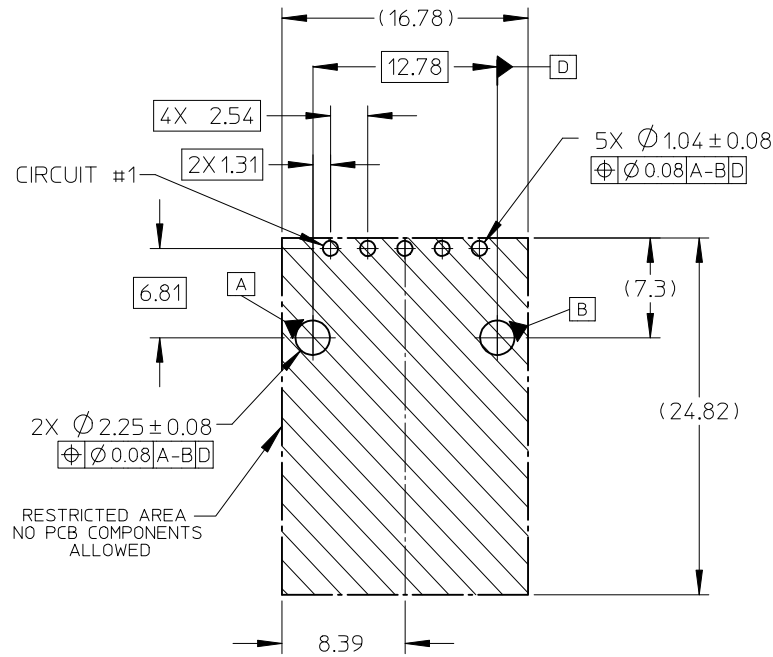

5 WAY PCB LAYOUT COMPONENT SIDE
RECOMMENDED PCB THICKNESS 1.57±0.17

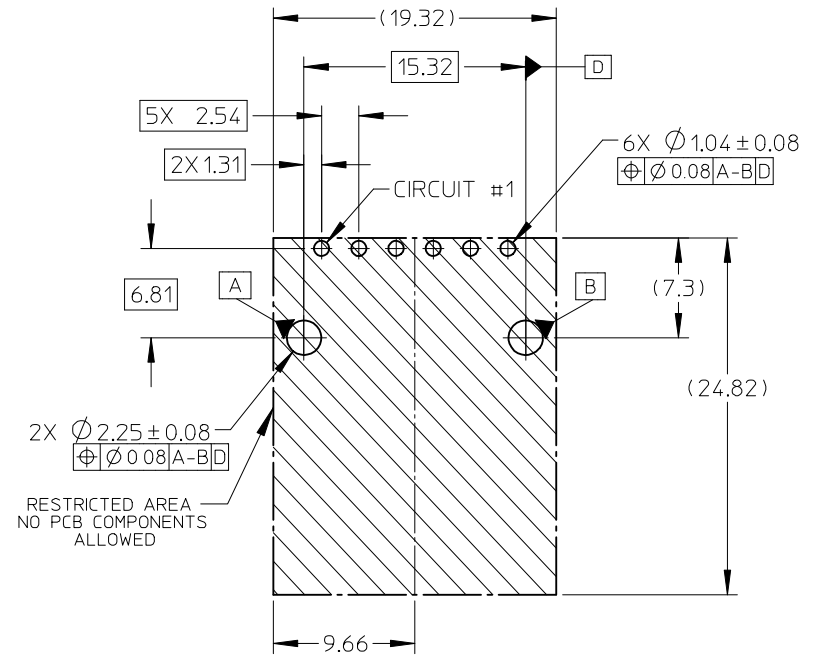

6 WAY PCB LAYOUT COMPONENT SIDE
RECOMMENDED PCB THICKNESS 1.57±0.17

ENTER DESCRIPTION EC NO: UAU2009-0141 DRAWN: CDILLON 2008/09/15 CHKD: CDILLON 2008/09/15 APPR: SWARCEAU 2008/09/15	QUALITY SYMBOLS ▽=0 ▽=0	GENERAL TOLERANCES (UNLESS SPECIFIED)		DIMENSION STYLE MM ONLY		SCALE	DESIGN UNITS METRIC	THIRD ANGLE PROJECTION		
		mm	INCH	DRAWN BY	DATE	TITLE RIGHT ANGLE HEADER ASSEMBLY CHARTED SALES DRAWING				
		4 PLACES ± ---	± ---	MDEVITO	01/12/06					
		3 PLACES ± ---	± ---	CHECKED BY	DATE	MOLEX INCORPORATED				
2 PLACES ± 0.13	± ---	BCOURIM	01/12/07							
1 PLACE ± 0.25	± ---	APPROVED BY	DATE	MATERIAL NO.		DOCUMENT NO.		SHEET NO.		
ANGULAR ±1/2°		DRAFT WHERE APPLICABLE MUST REMAIN WITHIN DIMENSIONS		SEE CHART		SD-31197-003		8 OF 8		
THIS DRAWING CONTAINS INFORMATION THAT IS PROPRIETARY TO MOLEX INCORPORATED AND SHOULD NOT BE USED WITHOUT WRITTEN PERMISSION										